

M2i.49xx - 8 channel 16 bit A/D up to 60 MS/s

- 2, 4 or 8 channels with 10 MS/s up to 60 MS/s
- Software selectable single-ended or differential inputs
- Simultaneously sampling on all channels
- Additional digital inputs as option available
- Separate ADC and amplifier per channel
- complete on-board calibration
- 6 input ranges: ± 200 mV up to ± 10 V
- Up to 1 GSample on-board memory
- 256 MSample standard on-board memory
- Programmable input offset of $\pm 100\%$
- Window, pulse width, re-arm, spike, OR/AND trigger
- Synchronization of up to 16 cards per system and up to 271 cards with system sync
- Features: Streaming, ABA mode, Multiple Recording, Gated Sampling

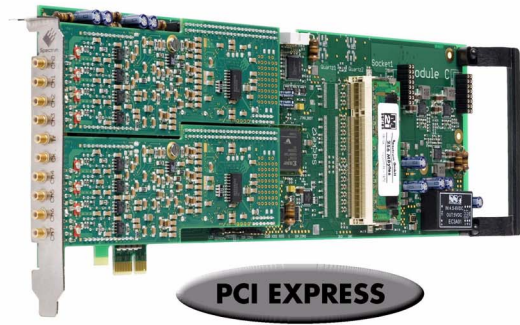
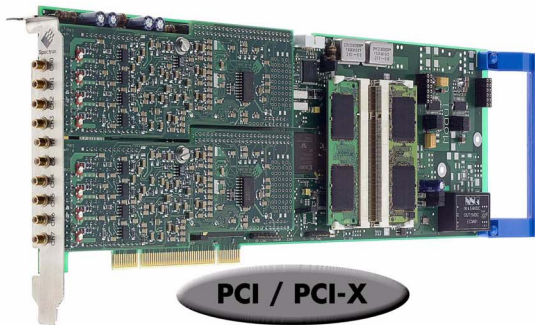

- 66 MHz 32 bit PCI-X interface
- 5V / 3.3V PCI compatible
- 100% compatible to conventional PCI > V2.1
- Sustained streaming mode up to 245 MB/s

- 2,5 GBit x1 PCIe Interface
- Works with x1/x4/x8/x16* PCIe slots
- Software compatible to PCI
- Sustained streaming mode up to 160 MB/s

<u>Operating Systems</u>	<u>Recommended Software</u>	<u>Drivers</u>
<ul style="list-style-type: none"> • Windows 7 (SP1), 8, 10, Server 2008 R2 and newer • Linux Kernel 2.6, 3.x, 4.x, 5.x • Windows/Linux 32 and 64 bit 	<ul style="list-style-type: none"> • Visual C++, Delphi, C++ Builder, GNU C++, VB.NET, C#, J#, Java, Python • SBench 6 	<ul style="list-style-type: none"> • MATLAB • LabVIEW • LabWindows/CVI

Model	1 channel	2 channels	4 channels	8 channels
M2i.4911	10 MS/s SE 10 MS/s Diff	10 MS/s SE 10 MS/s Diff	10 MS/s SE	
M2i.4912	10 MS/s SE 10 MS/s Diff	10 MS/s SE 10 MS/s Diff	10 MS/s SE 10 MS/s Diff	10 MS/s SE
M2i.4931	30 MS/s SE 30 MS/s Diff	30 MS/s SE 30 MS/s Diff	30 MS/s SE	
M2i.4932	30 MS/s SE 30 MS/s Diff	30 MS/s SE 30 MS/s Diff	30 MS/s SE 30 MS/s Diff	30 MS/s SE
M2i.4960	60 MS/s SE 60 MS/s Diff	60 MS/s SE 60 MS/s Diff	60 MS/s SE 60 MS/s Diff	
M2i.4961	60 MS/s SE 60 MS/s Diff	60 MS/s SE 60 MS/s Diff	60 MS/s SE 60 MS/s Diff	
M2i.4963	60 MS/s SE 60 MS/s Diff	60 MS/s SE 60 MS/s Diff	30 MS/s SE	
M2i.4964	60 MS/s SE 60 MS/s Diff	60 MS/s SE 60 MS/s Diff	60 MS/s SE 60 MS/s Diff	30 MS/s SE

SE = Single Ended Input
Diff = True Differential Input

General Information

The M2i.49xx series allows recording of up to eight channels with sampling rates of 30 MS/s or four channels with sampling rates of 60 MS/s. These cards offer outstanding A/D features both in resolution and speed for PCI/PCI-X and PCI Express. The cards can be switched between Single-Ended inputs with a programmable offset and true differential inputs. If used in differential mode each two inputs are connected together reducing the number of available channels by half.

The 16 bit vertical resolution have four times the accuracy compared to 14 bit cards and sixteen times the accuracy if compared with a 12 bit card. All boards of the M2i.49xx series may use the whole installed on-board memory of up to 1 GSamples, completely for the currently activated number of channels.

*Some x16 PCIe slots are for the use of graphic cards only and can not be used for other cards.

Software Support

Windows drivers

The cards are delivered with drivers for Windows 7, Windows 8 and Windows 10 (32 bit and 64 bit). Programming examples for Visual C++, C++ Builder, Delphi, Visual Basic, VB.NET, C#, J#, Python, Java and IVI are included.

Linux Drivers



All cards are delivered with full Linux support. Pre compiled kernel modules are included for the most common distributions like Fedora, Suse, Ubuntu LTS or Debian. The Linux support includes SMP systems, 32 bit and 64 bit systems, versatile programming examples for GNU C++, Python as well as the possibility to get the driver sources for your own compilation.

SBench 6

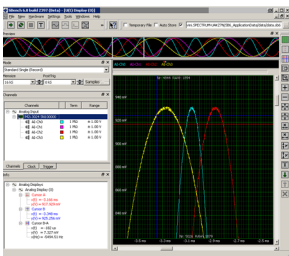

A base license of SBench 6, the easy-to-use graphical operating software for Spectrum cards, is included in the delivery. The base license makes it possible to test the card, display acquired data and make some basic measurements. It's a valuable tool for checking the card's performance and assisting with the unit's initial setup. The cards also come with a demo license for the SBench 6 professional version. This license gives the user the opportunity to test the additional features of the professional version with their hardware. The professional version contains several advanced measurement functions, such as FFTs and X/Y display, import and export utilities as well as support for all acquisition modes including data streaming. Data streaming allows the cards to continuously acquire data and transfer it directly to the PC RAM or hard disk. SBench 6 has been optimized to handle data files of several GBytes. SBench 6 runs under Windows as well as Linux (KDE, GNOME and Unity) operating systems. A test version of SBench 6 can be downloaded directly over the internet and can run the professional version in a simulation mode without any hardware installed. Existing customers can also request a demo license for the professional version from Spectrum. More details on SBench 6 can be found in the SBench 6 data sheet.

Third-party Software Products

Most popular third-party software products, such as LabVIEW, MATLAB or LabWindows/CVI are supported. All drivers come with examples and detailed documentation.

Hardware features and options

PCI/PCI-X



The cards with PCI/PCI-X bus connector use 32 Bit and up to 66 MHz clock rate for data transfer. They are 100% compatible to Conventional PCI > V2.1. The universal interface allows the use in PCI slots with 5 V I/O and 3.3 V I/O voltages as well as in PCI-

X or PCI 64 slots. The maximum sustained data transfer rate is 245 MByte/s per bus segment.

PCI Express



The cards with PCI Express use a x1 PCIe connector. They can be used in PCI Express x1/x4/x8/x16 slots, except special graphic card slots, and are 100% software compatible to Conventional PCI > V2.1. The maximum sustained data transfer rate is

160 MByte/s per slot.

Input Amplifier

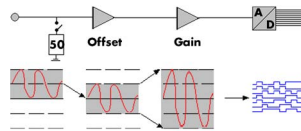

The analog inputs can be adapted to real world signals using a wide variety of settings that are individual for each channel. By using software commands the input termination can be changed

between 50 Ohm and 1 MOhm, one can select a matching input range and the signal offset can be compensated for.

Differential inputs

With a simple software command the inputs can individually be switched from single-ended (in relation to ground) to differential by combining each two single-ended inputs to one differential input. When the inputs are used in differential mode the A/D converter measures the difference between two lines with relation to system ground.

Automatic on-board calibration

All of the channels are calibrated in factory before the board is shipped. To compensate for different variations like PC power supply, temperature and aging, the software driver provides routines for an automatic onboard offset and gain calibration of all input ranges. All the cards contain a high precision on-board calibration reference.

Digital inputs

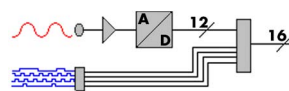

This option acquires additional synchronous digital channels phase-stable with the analog data. When the option is installed there are 16 additional digital inputs on 4 channel A/D instruments and 32 digital inputs on A/D instruments with 8 and more channels.

The digital inputs can be multiplexed into the analog data by software command using many different formats:

The digital inputs can be multiplexed into the analog data by software command using many different formats:

- Each 16 digital inputs can replace one analog channel.
- Each 2 digital inputs can be multiplexed into an analog channel with a resolution reduced to 14 bit.
- Each 4 digital inputs can be multiplexed into an analog channel with a resolution reduced to 12 bit.

Ring buffer mode

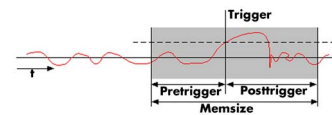

The ring buffer mode is the standard mode of all oscilloscope instruments. Digitized data is continuously written into a ring memory until a

trigger event is detected. After the trigger, post-trigger samples are recorded and pre-trigger samples can also be stored. The number of pre-trigger samples available simply equals the total ring memory size minus the number of post trigger samples.

FIFO mode

The FIFO mode is designed for continuous data transfer between measurement board and PC memory (up to 245 MB/s on a PCI-X slot, up to 125 MB/s on a PCI slot and up to 160 MB/s on a PCIe

slot) or hard disk. The control of the data stream is done automatically by the driver on interrupt request. The complete installed on-board memory is used for buffer data, making the continuous streaming extremely reliable.

Channel trigger

The data acquisition instruments offer a wide variety of trigger modes. Besides the standard signal checking for level and edge as known from oscilloscopes it's also possible to define a window trigger. This makes it possible to trigger on signal errors like too long or too short pulses. In addition to this a re-arming mode (for accurate trigger recognition on noisy signals) the AND/OR conjunction of different trigger events is possible. As a unique feature it is possible to use deactivated channels as trigger sources.

External trigger I/O

All instruments can be triggered using an external TTL signal. It's possible to use positive or negative edge also in combination with a programmable pulse width. An internally recognised trigger event can - when activated by software - be routed to the trigger connector to start external instruments.

Pulse width

Defines the minimum or maximum width that a trigger pulse must have to generate a trigger event. Pulse width can be combined with channel trigger, pattern trigger and external trigger.

Multiple Recording

The Multiple Recording mode allows the recording of several trigger events with an extremely short re-arming time. The hardware doesn't need to be restarted in between. The on-board memory is divided in several segments of the same size. Each of them is filled with data if a trigger event occurs. Pre- and posttrigger of the segments can be programmed. The number of acquired segments is only limited by the used memory and is unlimited when using FIFO mode.

Gated Sampling

The Gated Sampling mode allows data recording controlled by an external gate signal. Data is only recorded if the gate signal has a programmed level. In addition a pre-area before start of the gate signal as well as a post area after end of the gate signal can be acquired. The number of gate segments is only limited by the used memory and is unlimited when using FIFO mode.

Timestamp

The timestamp function writes the time positions of the trigger events in an extra memory. The timestamps are relative to the start of recording, a defined zero time, externally synchronized to a radio clock, an IRIG-B or a GPS receiver. Using the external synchronization gives a precise time relation for acquisitions of systems on different locations.

External clock output

Using a dedicated connector it is possible to output the internally used sampling clock to synchronize external equipment to this clock.

ABA mode

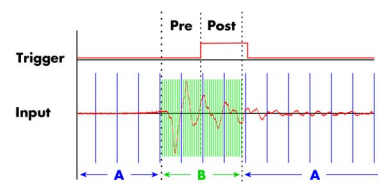

The ABA mode combines slow continuous data recording with fast acquisition on trigger events. The ABA mode works like a slow data logger combined with a fast digitizer. The exact

position of the trigger events is stored as timestamps in an extra memory.

Reference clock

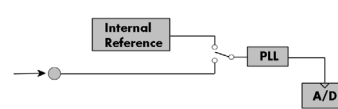

The option to use a precise external reference clock (normally 10 MHz) is necessary to synchronize the instrument for high-quality measurements with external equipment (like a signal source). It's also possible to enhance the quality of the sampling clock in this way. The driver automatically generates the requested sampling clock from the fed in reference clock.

Star-Hub



The star-hub is an additional module allowing the phase stable synchronisation of up to 16 boards in one system. Independent of the number of boards there is no phase delay between all channels. The star-hub distributes trigger and

clock information between all boards. As a result all connected boards are running with the same clock and the same trigger. All trigger sources can be combined with OR/AND allowing all channels of all cards to be trigger source at the same time. The star-hub is available as 5 card and 16 card version. The 5 card version doesn't need an extra slot.

271 synchronous cards with the System Star-Hub

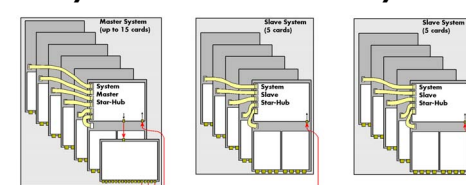

With the help of multiple system star-hubs it is possible to link up to 17 system phase synchronous with each other.

Each system can then contain up to 16 cards (master only 15). In total 271 cards can be used fully synchronously in a bunch of systems. One master system distributes clock and trigger signal to all connected slave systems.

BaseXIO (Asynchronous I/O, enhanced trigger)



The BaseXIO option offers 8 asynchronous digital I/O lines on the base card. The direction can be selected by software in groups of four. This allows e.g. external equipment control or status monitoring. Two of these lines can also be used as additional external trigger sources. This allows the building of complex trigger conjunctions with external gated triggers as well as AND/OR conjunction of multiple external trigger sources like, for example, the picture and row synchronisation of video signals. In addition one of the I/O lines can be used as reference clock for the Timestamp counter.

Technical Data

Analog Inputs

Resolution		16 bit (can be reduced to acquire simultaneous digital inputs)
Input Range	software programmable	± 200 mV, ± 500 mV, ± 1 V, ± 2 V, ± 5 V, ± 10 V
Input Type	software programmable	Single-ended or True Differential
Input Offset (single-ended)	software programmable	programmable to $\pm 100\%$ of input range in steps of 1%
ADC Differential non linearity (DNL)	ADC only	491x + 493x: ± 1.2 LSB; 496x: ± 1.4 LSB
ADC Integral non linearity (INL)	ADC only	491x + 493x: ± 5.5 LSB; 496x: ± 6.5 LSB
Offset error (full speed)	after warm-up and calibration	$\leq 0.1\%$
Gain error (full speed)	after warm-up and calibration	$\leq 0.1\%$
Crosstalk: Signal ≤ 1 MHz, 50 ohm	range $\leq \pm 1$ V	≤ 100 dB on adjacent channels (all card types)
Crosstalk: Signal ≤ 1 MHz, 50 ohm	range $\geq \pm 2$ V	≤ 58 dB on adjacent channels (M2i.491x, M2i.493x, M2i.4963, M2i.4964)
Crosstalk: Signal ≤ 1 MHz, 50 ohm	range $\geq \pm 2$ V	≤ 80 dB on adjacent channels (M2i.4960, M2i.4961)
Analog Input impedance	software programmable	50 Ohm / 1 MOhm TBD pF
Analog input coupling	fixed	DC
Over voltage protection	range $\leq \pm 1$ V	± 5 V
Over voltage protection	range $\geq \pm 2$ V	± 40 V
CMRR (Common Mode Rejection Ratio)	range $\leq \pm 1$ V	100 kHz: 80 dB, 1 MHz: 59 dB, 10 MHz: 41 dB
CMRR (Common Mode Rejection Ratio)	range $\geq \pm 2$ V	100 kHz: 59 dB, 1 MHz: 53 dB, 10 MHz: 52 dB
Channel selection (single-ended inputs)	software programmable	1, 2, 4 or 8 channels (maximum is model dependent)
Channel selection (true differential inputs)	software programmable	1, 2 or 4 channels (maximum is model dependent)

Trigger

Available trigger modes	software programmable	Channel Trigger, External, Software, Window, Pulse, Re-Arm, Spike, Or/And, Delay
Trigger level resolution	software programmable	14 bit
Trigger edge	software programmable	Rising edge, falling edge or both edges
Trigger pulse width	software programmable	0 to [64k - 1] samples in steps of 1 sample
Trigger delay	software programmable	0 to [64k - 1] samples in steps of 1 sample
Multi, Gate: re-arming time		< 4 samples (+ programmed pretrigger)
Pretrigger at Multi, ABA, Gate, FIFO	software programmable	4 up to [8176 Samples / number of active channels] in steps of 4
Posttrigger	software programmable	4 up to [8 - 4] samples in steps of 4 (defining pretrigger in standard scope mode)
Memory depth	software programmable	8 up to [installed memory / number of active channels] samples in steps of 4
Multiple Recording/ABA segment size	software programmable	8 up to [installed memory / 2 / active channels] samples in steps of 4
Trigger output delay		One positive edge after internal trigger event
Internal/External trigger accuracy		1 sample
External trigger type (input and output)		3.3V LVTTTL compatible (5V tolerant with base card hardware version > V20)
External trigger input		Low ≤ 0.8 V, High ≥ 2.0 V, ≥ 8 ns in pulse stretch mode, ≥ 2 clock periods all other modes
External trigger maximum voltage		-0.5 V up to +5.7 V (internally clamped to 5.0V, 100 mA max. clamping current)
Trigger impedance	software programmable	50 Ohm / high impedance (> 4kOhm)
External trigger output type		3.3 V LVTTTL
External trigger output levels		Low ≤ 0.4 V, High ≥ 2.4 V, TTL compatible
External trigger output drive strength		Capable of driving 50 ohm load, maximum drive strength ± 128 mA

Clock

Clock Modes	software programmable	internal PLL, internal quartz, external reference clock, sync
Internal clock range (PLL mode)	software programmable	1 kS/s to max using internal reference, 50kS/s to max using external reference clock
Internal clock accuracy		≤ 20 ppm
Internal clock setup granularity		$\leq 1\%$ of range (100M, 10M, 1M, 100k,...): Examples: range 1M to 10M: stepsize $\leq 100k$
External reference clock range	software programmable	≥ 1.0 MHz and ≤ 125.0 MHz
External reference clock impedance	software programmable	50 Ohm / high impedance (> 4kOhm)
External reference clock range		see „Dynamic Parameters“ table below
External reference clock delay to internal clock		5.4 ns
External reference clock type/edge		3.3V LVTTTL compatible, rising edge used
External reference clock input		Low level ≤ 0.8 V, High level ≥ 2.0 V, duty cycle: 45% - 55%
External reference clock maximum voltage		-0.5 V up to +3.8 V (internally clamped to 3.3V, 100 mA max. clamping current)
Internal ADC clock output type		3.3 V LVTTTL
Internal ADC clock output levels		Low ≤ 0.4 V, High ≥ 2.4 V, TTL compatible
Internal ADC clock output drive strength		Capable of driving 50 ohm load, maximum drive strength ± 128 mA
Synchronization clock divider	software programmable	2 up to [8k - 2] in steps of 2
ABA mode clock divider for slow clock	software programmable	8 up to 524280 in steps of 8
Minimum ADC clock before using Oversampling		3 MS/s

Digital Inputs Option

Digital data acquisition modes	software programmable	per channel: ADC 16 bit, ADC 14 bit + 2 DI, ADC 12 bit + 4 DI, replace ADC with 16 DI
Digital inputs delay to analog sample		0 Samples
Input Impedance		> 4,7 kOhm with Bus-Hold circuitry, unused inputs can be left floating, override current ≥ 500 μ A
Maximum voltage		-0.3 V up to +5.5 V (internally clamped to 3.3V and ground, 200 mA max. clamping current)
Input voltage		Low ≤ 0.8 V, High ≥ 2.0 V (TTL compatible)

BaseXIO Option

BaseXIO modes	software programmable	Asynch digital I/O, 2 additional trigger, timestamp reference clock, timestamp digital inputs
BaseXIO direction	software programmable	Each 4 lines can be programmed in direction
BaseXIO input		TTL compatible: Low ≤ 0.8 V, High ≥ 2.0 V
BaseXIO input impedance		4.7 kOhm towards 3.3 V
BaseXIO input maximum voltage		-0.5 V up to +5.5 V
BaseXIO output type		3.3 V LVTTL
BaseXIO output levels		TTL compatible: Low ≤ 0.4 V, High ≥ 2.4 V
BaseXIO output drive strength		32 mA maximum current, no 50 Ω loads

Connectors

Analog Inputs		3 mm SMB male (one for each single-ended input)	Cable-Type: Cab-3f-xx-xx
Trigger Input/Output	programmable direction	3 mm SMB male (one connector)	Cable-Type: Cab-3f-xx-xx
Clock Input/Output	programmable direction	3 mm SMB male (one connector)	Cable-Type: Cab-3f-xx-xx
Option Digital Inputs/Outputs		40 pole half pitch (Hirose FX2 series)	Cable-Type: Cab-d40-xx-xx
Option BaseXIO		8 x 3 mm SMB male on extra bracket, internally 8 x MMCX female	

Environmental and Physical Details

Dimension (PCB only)	312 mm x 107 mm (full PCI length)
Width (Standard or with option star-hub 5)	1 full size slot
Width (star-hub 16)	additionally back of adjacent neighbour slots
Width (with option BaseXIO)	additionally extra bracket on neighbour slot
Width (with option -digin, -digout or -60xx-AmpMod)	additionally half length of adjacent neighbour slot
Weight (depending on version)	290g (smallest version) up to 460g (biggest version with all options, including star-hub)
Warm up time	10 minutes
Operating temperature	0°C to 50°C
Storage temperature	-10°C to 70°C
Humidity	10% to 90%

PCI/PCI-X specific details

PCI / PCI-X bus slot type	32 bit 33 MHz or 32 bit 66 MHz
PCI / PCI-X bus slot compatibility	32/64 bit, 33-133 MHz, 3,3 V and 5 V I/O
Sustained streaming mode	> 245 MB/s (in a PCI-X slot clocked at 66 MHz or higher)

PCI Express specific details

PCIe slot type	x1 Generation 1
PCIe slot compatibility (physical)	x1, x4, x8, x16
PCIe slot compatibility (electrical)	x1, x2, x4, x8, x16 with Generation 1, Generation 2, Generation 3, Generation 4
Sustained streaming mode	> 160 MB/s

Certification, Compliance, Warranty

EMC Immunity	Compliant with CE Mark
EMC Emission	Compliant with CE Mark
Product warranty	5 years starting with the day of delivery
Software and firmware updates	Life-time, free of charge

Power Consumption

	PCI / PCI-X			PCI EXPRESS		
	3.3 V	5 V	Total	3.3V	12V	Total
M2i.4911, 4931, 4960, 4963 (256 MS memory)	2.7 A	0.8 A	12.9 W	0.5 A	1.3 A	17.3 W
M2i.4912, 4932, 4961, 4964 (256 MS memory)	3.3 A	1.6 A	18.9 W	0.5 A	1.7 A	22.0 W
M2i.4964 (2 GS memory), max power	4.4 A	1.6 A	22.5 W	0.5 A	2.2 A	28.0 W

MTBF

MTBF	200000 hours
------	--------------

Dynamic Parameters

	M2i.491x DN2.491-xx DN6.491-xx	M2i.4931 M2i.4932	M2i.496x DN2.496-xx DN6.496-xx
max internal/external clock	10 MS/s	31.25 MS/s	62.5 MS/s
min internal clock	1 kS/s	1 kS/s	1 kS/s
min external reference clock	1 MS/s	1 MS/s	1 MS/s
-3 dB bandwidth	> 5 MHz	> 15 MHz	> 30 MHz
Zero noise level (Range ± 200 mV and ± 2 V)	< 5.0 LSB rms	< 5.5 LSB rms	< 7.0 LSB rms
Zero noise level (all other ranges)	< 4.0 LSB rms	< 4.5 LSB rms	< 5.0 LSB rms
Test - sampling rate	10 MS/s	30 MS/s	60 MS/s
Test signal frequency	1 MHz	1 MHz	1 MHz
SNR (typ)	≥ 77.1 dB	≥ 76.4 dB	≥ 74.5 dB
THD (typ)	≤ -80.0 dB	≤ -80.5 dB	≤ -80.0 dB
SFDR (typ), excl. harm.	≥ 94.3 dB	≥ 93.3 dB	≥ 92.2 dB
ENOB (based on SNR)	≥ 12.5 LSB	≥ 12.3 LSB	≥ 12.1 LSB
ENOB (based on SINAD)	≥ 12.2 LSB	≥ 12.2 LSB	≥ 12.0 LSB

Dynamic parameters are measured at ± 1 V input range (if no other range is stated) and 50Ω termination with the samplerate specified in the table. Measured parameters are averaged 20 times to get typical values. Test signal is a pure sine wave generated by a signal generator and a matching bandpass filter. Amplitude is $>99\%$ of FSR. SNR and RMS noise parameters may differ depending on the quality of the used PC. SNR = Signal to Noise Ratio, THD = Total Harmonic Distortion, SFDR = Spurious Free Dynamic Range, SINAD = Signal Noise and Distortion, ENOB = Effective Number of Bits.

Hardware block diagram

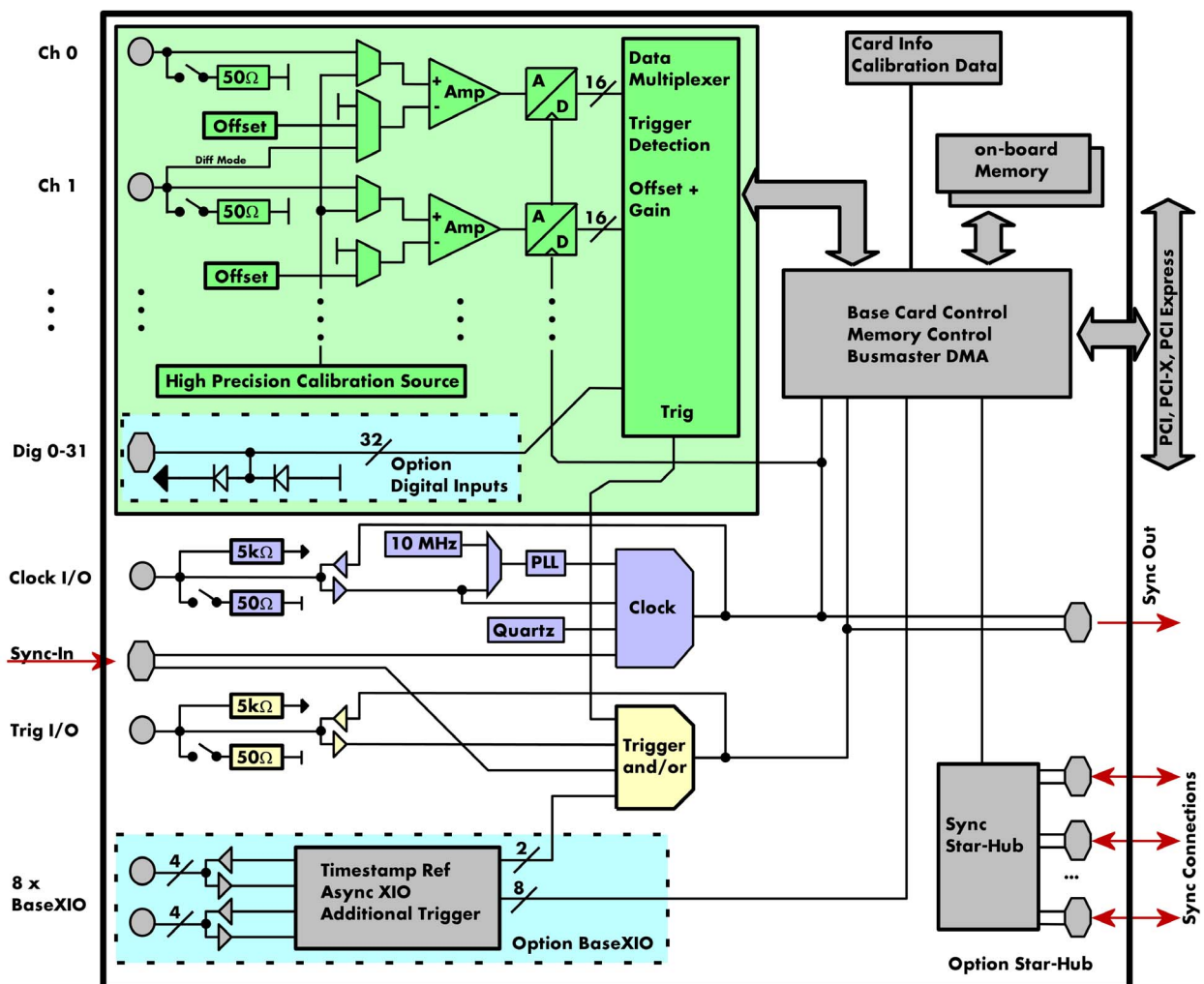

Order Information

The card is delivered with 256 MSample on-board memory and supports standard acquisition (Scope), FIFO acquisition (streaming), Multiple Recording, Gated Sampling, ABA mode and Timestamps. Operating system drivers for Windows/Linux 32 bit and 64 bit, examples for C/C++, LabVIEW (Windows), MATLAB (Windows and Linux), IVI, .NET, Delphi, Java, Python and a Base license of the oscilloscope software SBench 6 are included. Drivers for other 3rd party products like VEE or DASyLab may be available on request.

Adapter cables are not included. Please order separately!

PCI/PCI-X PCI Express

Order no. PCI Express	Order no. PCI/PCI-X	Standard mem	1 channel	2 channels	4 channels	8 channels
M2i.4911-exp	M2i.4911	256 MSample	10 MS/s	10 MS/s	10 MS/s	
M2i.4912-exp	M2i.4912	256 MSample	10 MS/s	10 MS/s	10 MS/s	10 MS/s
M2i.4931-exp	M2i.4931	256 MSample	30 MS/s	30 MS/s	30 MS/s	
M2i.4932-exp	M2i.4932	256 MSample	30 MS/s	30 MS/s	30 MS/s	30 MS/s
M2i.4960-exp	M2i.4960	256 MSample	60 MS/s	60 MS/s		
M2i.4961-exp	M2i.4961	256 MSample	60 MS/s	60 MS/s	60 MS/s	
M2i.4963-exp	M2i.4963	256 MSample	60 MS/s	60 MS/s	30 MS/s	
M2i.4964-exp	M2i.4964	256 MSample	60 MS/s	60 MS/s	60 MS/s	30 MS/s

Memory

Order no.	Option
M2i.xxxx-512MS	Memory upgrade to 512 MSample (1 GB) total memory
M2i.xxxx-1GS	Memory upgrade to 1 GSample (2 GB) total memory

Options

Order no.	Option
M2i.xxxx-SH5 (1)	Synchronization Star-Hub for up to 5 cards, only 1 slot width
M2i.xxxx-SH16 (1)	Synchronization Star-Hub for up to 16 cards
M2i.xxxx-SSHM (1)	System-Star-Hub Master for up to 15 cards in the system and up to 17 systems, PCI 32 Bit card, sync cables and extra bracket for clock and trigger distribution included
M2i.xxxx-SSHMe (1)	System-Star-Hub Master for up to 15 cards in the system and up to 17 systems, PCI Express card, sync cables and extra bracket for clock and trigger distribution included
M2i.xxxx-SSHS5 (1)	System-Star-Hub Slave for 5 cards in one system, one slot width all sync cables + bracket included
M2i.xxxx-SSHS16 (1)	System-Star-Hub Slave for 16 cards in system, two slots width, all sync cables + bracket included
M2i.49xx-dig	Additional synchronous digital inputs with multiple data formats (16 digital channels on 2 and 4 channel cards and 32 digital channels on 8 channel cards) including Cab-d40-idx-100
M2i.496x-hbw	65 MHz high bandwidth option for all M2i.496x cards
M2i.xxxx-bxio	Option BaseXIO: 8 digital I/O lines usable as asynchronous I/O, timestamp ref-clock and additional external trigger lines, additional bracket with 8 SMB connectors
M2i-upgrade	Upgrade for M2i.xxxx: later installation of option -M2i.xxxx-1GS, -SH5, -SH16 or -bxio

Services

Order no.	
Recal	Recalibration at Spectrum incl. calibration protocol

Amplifiers

Order no.	Bandwidth	Connection	Input Impedance	Coupling	Amplification
SPA.1412 ⁽²⁾	200 MHz	BNC	1 MOhm	AC/DC	x10/x100 (20/40 dB)
SPA.1411 ⁽²⁾	200 MHz	BNC	50 Ohm	AC/DC	x10/x100 (20/40 dB)
SPA.1232 ⁽²⁾	10 MHz	BNC	1 MOhm	AC/DC	x100/x1000 (40/60 dB)
SPA.1231 ⁽²⁾	10 MHz	BNC	50 Ohm	AC/DC	x100/x1000 (40/60 dB)
Information	External Amplifiers with one channel, BNC/SMA female connections on input and output, manually adjustable offset, manually switchable settings. An external power supply for 100 to 240 VAC is included. Please be sure to order an adapter cable matching the amplifier connector type and matching the connector type for your A/D card input.				

Cables

for Connections	Length	Order no.				
		to BNC male	to BNC female	to SMA male	to SMA female	to SMB female
Analog/Clock/Trigger	80 cm	Cab-3f-9m-80	Cab-3f-9f-80	Cab-3f-3mA-80	Cab-3f-3fA-80	Cab-3f-3f-80
Analog/Clock/Trigger	200 cm	Cab-3f-9m-200	Cab-3f-9f-200	Cab-3f-3mA-200	Cab-3f-3fA-200	Cab-3f-3f-200
Probes (short)	5 cm		Cab-3f-9f-5			
Information	The standard adapter cables are based on RG174 cables and have a nominal attenuation of 0.3 dB/m at 100 MHz.					
			to 40 pole FX2			
Digital signals (option)	100 cm	Cab-d40-idx-100	Cab-d40-d40-100			

Software SBench6

Order no.	
SBench6	Base version included in delivery. Supports standard mode for one card.
SBench6-Pro	Professional version for one card: FIFO mode, export/import, calculation functions
SBench6-Multi	Option multiple cards: Needs SBench6-Pro. Handles multiple synchronized cards in one system.
Volume Licenses	Please ask Spectrum for details.

Software Options

Order no.	
SPc-RServer	Remote Server Software Package - LAN remote access for M2i/M3i/M4i/M4x/M2p cards

⁽¹⁾ : Just one of the options can be installed on a card at a time.

⁽²⁾ : Third party product with warranty differing from our export conditions. No volume rebate possible.

Technical changes and printing errors possible

SBench, digitizerNETBOX and generatorNETBOX are registered trademarks of Spectrum Instrumentation GmbH. Microsoft, Visual C++, Windows, Windows 98, Windows NT, Window 2000, Windows XP, Windows Vista, Windows 7, Windows 8 and Windows 10 are trademarks/registered trademarks of Microsoft Corporation. LabVIEW, DASyLab, Diadem and LabWindows/CVI are trademarks/registered trademarks of National Instruments Corporation. MATLAB is a trademark/registered trademark of The Mathworks, Inc. Delphi and C++Builder are trademarks/registered trademarks of Embarcadero Technologies, Inc. Keysight VEE, VEE Pro and VEE OneLab are trademarks/registered trademarks of Keysight Technologies, Inc. FlexPro is a registered trademark of Weisang GmbH & Co. KG. PCIe, PCI Express and PCI-X and PCI-SIG are trademarks of PCI-SIG. LXI is a registered trademark of the LXI Consortium. PICMG and CompactPCI are trademarks of the PCI Industrial Computation Manufacturers Group. Oracle and Java are registered trademarks of Oracle and/or its affiliates. Intel and Intel Core i3, Core i5, Core i7, Core i9 and Xeon are trademarks and/or registered trademarks of Intel Corporation. AMD, Opteron, Sempron, Phenom, FX, Ryzen and EPYC are trademarks and/or registered trademarks of Advanced Micro Devices. NVIDIA, CUDA, GeForce, Quadro and Tesla are trademarks/registered trademarks of NVIDIA Corporation.