

M5i.63xx-x16 - 16 bit 10 GS/s Arbitrary Waveform Generator

- **Fast 16 bit arbitrary waveform generator**
- **One or two channels with up to 10 GS/s**
- **Output signal bandwidth up to 2.5 GHz**
- **Differential or single-ended output**
- **Single-ended output 1 Vpp/4 dBm into 50 Ω**
(2 Vpp into high impedance)
- **Differential output level 2 Vpp/10 dBm into 100 Ω**
(4 Vpp into high impedance)
- **Fixed trigger to output delay**
- **Ultra Fast PCI Express x16 Gen 3 interface**
- **2 GSample (8 GSample as option) on-board memory**
- **FIFO mode continuous streaming output**
- **Modes: Single-Shot, Repeated, Loop, FIFO, Multiple Replay**
- **Synchronization of up to 8 cards per system using star-hub**
- **Direct data transfer from CUDA GPU using SCAPP option**



- PCIe x16 Gen 3 Interface
- Sustained streaming mode up to 10.0 GByte/s*
- Included advanced cooling with dual cooling fans for proper airflow

Operating Systems

- Windows 7 (SP1), 8, 10, 11 Server 2008 R2 and newer
- Linux Kernel 3.x, 4.x, 5.x, 6.x
- Windows/Linux 32 and 64 bit

Programming Languages

- C, C++, C#, Python
- Julia, Java, VB.NET, Delphi
- IVI

Supported Software

- SBench 6
- MATLAB
- LabVIEW

Model	Bandwidth	1 channel	2 channels
M5i.6357-x16	2.5 GHz	10 GS/s	5 GS/s
M5i.6350-x16	2.5 GHz	10 GS/s	
M5i.6321-x16	1.5 GHz	3.2 GS/s	3.2 GS/s
M5i.6320-x16	1.5 GHz	3.2 GS/s	

General Information

The 63xx series arbitrary waveform generators deliver the highest performance in both speed and resolution. The series includes products with one or two channel and can be extended up to 16 synchronous channels using the star-hub. The 63xx products offer best AWG performance for multiple channels and signal frequencies up to 2.5 GHz with a high output level of up 1 Vpp single-ended into 50 Ohm or 2 Vpp differential into 100 Ohm.

While the cards have been designed using the latest technology they are still software compatible with the drivers from earlier Spectrum waveform generator cards. The same software developed for a 20 year old AWG card will work for an M5i series 10 GS/s AWG.

*Throughput measured with a motherboard chipset supporting a TLP size of 512 bytes.

Software Support

Windows drivers

The cards are delivered with drivers for Windows 7, Windows 8, Windows 10 and Windows 11 (32 bit and 64 bit). Programming examples for Visual C++, C++ Builder, Delphi, Visual Basic, VB.NET, C#, Julia, Python, Java and IVI are included.

Linux Drivers



All cards are delivered with full Linux support. Pre compiled kernel modules are included for the most common distributions like Fedora, Suse, Ubuntu LTS or Debian. The Linux support includes SMP systems, 32 bit and 64 bit systems, versatile programming examples for GNU C++, Python and Julia, as well as the possibility to get the kernel driver sources for your own compilation.

SBench 6

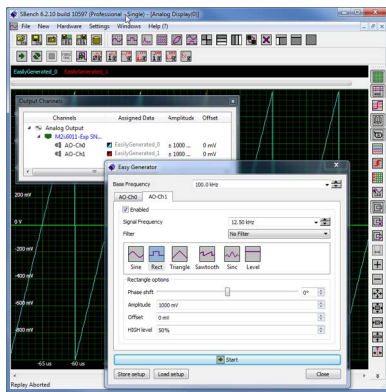

A base license of SBench 6, the easy-to-use graphical operating software for Spectrum cards, is included in the delivery. The base license makes it possible to test the card, generate simple signals or load and replay previously stored SBench 6 signals. It's a valuable tool for checking the cards performance and assisting

with the units initial setup. The cards also come with a demo license for the SBench6 professional version. This license gives the user the opportunity to test the additional features of the professional version with their hardware. The professional version contains several advanced measurement functions, such as FFTs and X/Y display, import and export utilities as well as support for all replay modes including data streaming. Data streaming allows the cards to continuously replay data and transfer it directly from the PC RAM or hard disk. SBench 6 has been optimized to handle data files of several GBytes. SBench 6 runs under Windows as well as Linux (KDE and GNOME) operating systems. A test version of SBench 6 can be downloaded directly over the internet and can run the professional version in a simulation mode without any hardware installed. Existing customers can also request a demo license for the professional version from Spectrum. More details on SBench 6 can be found in the SBench 6 data sheet.

SCAPP – CUDA GPU based data processing

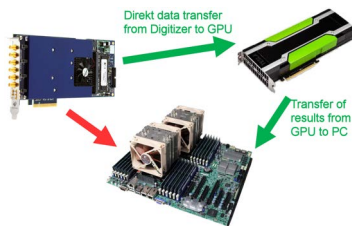

For applications requiring high performance signal and data processing Spectrum offers SCAPP (Spectrum's CUDA Access for Parallel Processing). The SCAPP SDK allows a direct link between Spectrum digitizers, AWGs, DDS or Digital Data Ac-

quisition Cards and CUDA based GPU cards. Once in the GPU users can harness the processing power of the GPU's multiple (up to 10000) processing cores and large (up to 48 GB) memories. SCAPP uses an RDMA (Linux only) process to send data at the full PCIe transfer speed to and from the GPU card. The SDK includes a set of examples for interaction between the Spectrum card and the

GPU card and another set of CUDA parallel processing examples with easy building blocks for basic functions like filtering, averaging, data de-multiplexing, data conversion or FFT. All the software is based on C/C++ and can easily be implemented, expanded and modified with normal programming skills.

Third-party products

Spectrum supports the most popular third-party software products such as LabVIEW or MATLAB. All drivers come with detailed documentation and working examples are included in the delivery.

Hardware features and options

PCI Express x16

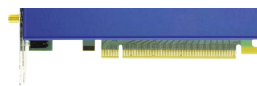

The M5i series cards use a PCI Express x16 Gen 3 connection. They can be used in PCI Express x16 slots with hosts supporting Gen1, Gen2, Gen3 or Gen4.

Gen3 or Gen4 is needed to get full performance. The maximum sustained data transfer rate is more than 12.8 GByte/s (read direction) or 10.0 GByte/s (write direction) per slot on systems with a PCIe payload size of 512. Physically supported slots that are electrically connected with less lanes can also be used with the M5i series cards, but with reduced data transfer rates.

Connections

The cards are equipped with SMA connectors for the analog signals as well as for clock input and output, trigger input and four multi-function I/O connectors (X0, X1, X2, X3). These multi-function connectors can be individually programmed to perform different functions:

- Trigger output
- Status output (armed, triggered, ready, ...)
- Digitizer: synchronous digital inputs, being stored inside the analog data samples
- AWGs: synchronous digital outputs, being stored inside the analog data samples
- Asynchronous I/O lines
- Logic trigger inputs

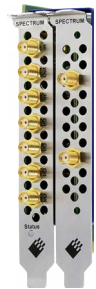

Automatic on-board calibration

All of the channels are calibrated in factory before the board is shipped. To compensate for different variations like PC power supply, temperature and aging, the software driver provides routines for an automatic on-board offset and gain calibration of output gain and offset. All the cards contain a high precision on-board calibration reference.

Singleshot output

When singleshot output is activated the data of the on-board memory is played exactly one time. The trigger source can be either one of the external trigger inputs or the software trigger. After the first trigger additional trigger events will be ignored.

Repeated output

When the repeated output mode is used the data of the on-board memory is played continuously for a programmed number of times or until a stop command is executed. The trigger source can be either one of the external trigger inputs or the software trigger. After the first trigger additional trigger events will be ignored.

Single Restart replay

When this mode is activated the data of the on-board memory will be replayed once after each trigger event. The trigger source can be either the external trigger or software trigger.

FIFO mode

The FIFO mode is designed for continuous data transfer between PC memory or hard disk and the generation board. The control of the data stream is done automatically by the driver on an interrupt request basis. The complete installed on-board memory is used for buffering data, making the continuous streaming extremely reliable.

Multiple Replay

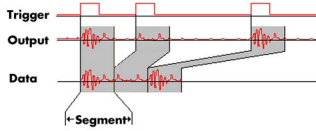

The Multiple Replay mode allows the fast output generation on several trigger events without restarting the hardware. With this option very fast repetition rates can be

achieved. The on-board memory is divided into several segments of the same size. Each segment can contain different data which will then be played with the occurrence of each trigger event.

External trigger input

All boards can be triggered using an external analog or digital signal. The external trigger input has one comparator that can be used for standard edge and level triggers.

External clock input and output

Using a dedicated connector a sampling clock can be fed in from an external system. Additionally it's also possible to output the internally used sampling clock on a separate connector to synchronize external equipment to this clock.

Reference clock

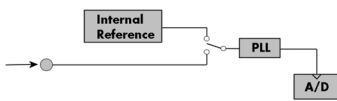

The option to use a precise external reference clock (normally 10 MHz) is necessary to synchronize the instrument for high-quality measurements with external equipment (like a signal source). It's also possible to enhance the quality of the sampling clock in this way. The driver automatically generates the requested sampling clock from the fed in reference clock.

Firmware Option Digital Pulse Generator

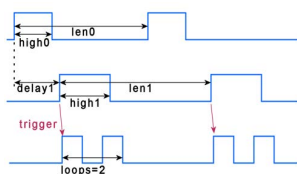

The digital pulse generator option adds 4 internal independent digital pulse generators with programmable duty cycle, output frequency, delay and number of loops.

These digital pulse generators can be triggered by software, hardware trigger or can trigger each other allowing to form complex pulse schemes to drive external equipment or experiments. The digital pulse generators can be output on the existing multi-XIO lines (X0, X1, ...) or can be used to trigger other pulse generators internally. Time resolution of the pulse generator depends on the cards type and the selected sampling rate and can be found in the technical data section.

The pulse generator option is a firmware option and can be later installed on all shipped cards.

Star-Hub



The Star-Hub is an additional module allowing the phase stable synchronization of up to 8 boards of one series and with same speed grade in one system. Independent of the number of boards there is no phase delay between all channels. The Star-Hub distributes trigger and clock information between all boards to ensure all connected boards are running with the same clock and trigger. All trigger sources can be combined with a logical OR allowing all channels of all cards to be the trigger source at the same time.

Technical Data



Only figures that are given with a maximum reading or with a tolerance reading are guaranteed specifications. All other figures are typical characteristics that are given for information purposes only. Figures are valid for products stored for at least 2 hours inside the specified operating temperature range, after a 30 minute warm-up, after running an on-board calibration and with proper cooled products. All figures have been measured in lab environment with an environmental temperature between 20°C and 25°C and an altitude of less than 100 m.

Analog Outputs

Resolution		16 bit	
D/A Interpolation		no interpolation	
Output Mode	software programmable	Single-Ended or Differential	
Output Enable/Disable	software programmable	Output disable cuts connection to DAC and terminates connector with 50 Ω to GND	

Single-Ended

Output amplitude	software programmable	into 50Ω ±1 mV up to ±500 mV	into high impedance ±2 mV up to ±1 V
Stepsize of output amplitude		1 mV	2 mV
Output offset	software programmable	±500 mV	±1.0 V
Maximum output voltage (offset + amplitude)		±750 mV	±1.5 V

Differential

Output amplitude (Differential signal)	software programmable	into 100Ω ±2 mV up to ±1 V	into high impedance ±4 mV up to ±2 V
Stepsize of output amplitude		2 mV	4 mV
Common Mode Voltage	software programmable	±500 mV	±1.0 V
Max output (common mode + single-ended amp)		±750 mV	±1.5 V

20% to 80% rise/fall time step response		240 ps	240 ps
DAC Differential non linearity (DNL)	DAC only	±2.2 LSB typical	
DAC Integral non linearity (INL)	DAC only	±9 LSB typical	
Output resistance		50 Ω	
Output coupling		DC	
Minimum output load		0 Ω (short circuit safe)	
Output amplitude accuracy (DC)		±2 mV ±1% of programmed output amplitude	
Output offset accuracy (DC)		±2 mV ±1% of programmed offset	
Offset temperature drift	after warm-up and calibration	TBD	
Gain temperature drift	after warm-up and calibration	TBD	
Calibration	Internal	Self-calibration is done on software command and corrects against the on-board references. Self-calibration should be issued after warm-up time.	
Calibration	External	External calibration calibrates the on-board references used in self-calibration. All calibration constants are stored in non-volatile memory. A yearly external calibration is recommended.	

Trigger

Available trigger modes	software programmable	External, Software, Or/And, Delay	
Trigger edge	software programmable	Rising edge, falling edge or both edges	
Trigger delay	software programmable	0 up to (256 GS - 32) in steps of 32	
Trigger holdoff (for Multi)	software programmable	0 up to (256 GS - 32) in steps of 32	
Memory depth	software programmable	64 up to (Installed memory / channels) in steps of 64	
Multiple Recording segment size	software programmable	64 up to (Installed memory / channels) in steps of 64	
Internal/External trigger accuracy		1 sample	
External trigger		Ext	X0, X1, X2, X3
External trigger type		single level comparator	3.3V LVTTTL logic inputs
External trigger impedance	software programmable	50 Ω or 3k Ω	For electrical specifications refer to „Multi Purpose I/O lines“ section.
External trigger input level		±5 V	
External trigger over voltage protection	50 Ω termination 3k Ω termination	±20 V 7 Vrms	
External trigger sensitivity (minimum required signal swing)		200 mVpp	
External trigger level	software programmable	±5 V with a stepsize of 10 mV	
External trigger bandwidth	50 Ω 3 kΩ 10 kΩ	DC to 2 GHz DC to 750 MHz n.a.	DC to 125 MHz n.a. DC to 125 MHz
Minimum external trigger pulse width		≥ 2 samples	≥ 2 samples
Resulting max detectable trigger frequency		[Current Samplerate]/2	[Current Samplerate]/2

Clock

Clock Modes	software programmable	internal PLL, external reference clock, star-hub synchronization clock
Internal clock accuracy		$\leq \pm 1$ ppm
Clock setup range		base frequency or divided base frequency
Clock setup base frequencies	M5i.6320/6321 M5i.6350/6357	TBD 10 GS/s
Clock setup divider		power of 2: 2, 4, 8, 16, 32, ..., 524288, 1048576
Clock setup examples	M5i.6320/6321 M5i.6350/6357	TBD 10.0, 5.0, 2.5, 1.25 GS/s, 625, 312.5 MS/s, ..., 5 kS/s
External reference clock range	software programmable	≥ 2 MHz and ≤ 750 MHz in steps of 2 MHz
External reference clock input impedance		50 Ω fixed
External reference clock input coupling		AC coupling
External reference clock input edge		Rising edge
External reference clock input type		Single-ended, sine wave or square wave
External reference clock input swing	min max	200 mVpp 3 Vpp
External reference clock input max DC voltage		± 10 V (with max 3.0 V difference between low and high level)
External reference clock input duty cycle requirement		45% to 55%
Clock setup granularity when using reference clock		divider: maximum sampling rate divided by: TBD
Internal reference clock output type		Single-ended, AC-coupled, LVPECL, 720 mVpp (typ)
Internal reference clock output frequency	M5i.6320/M5i.6321 M5i.6350/M5i.6357	clock setup base frequency / 64 (example: clock 3.2 GS/s -> output 50.000 MHz) clock setup base frequency / 128 (example: clock 5.0 GS/s -> output 39.0625 MHz)
Star-Hub synchronization clock modes	software programmable	Internal clock, External reference clock
Channel to channel skew on one card		TBD ns
Skew between star-hub synchronized cards	software programmable	skew adjustable up to ± 127 ps

Multi Purpose I/O lines (front-plate)

Number of multi purpose lines		four, named X0, X1, X2, X3
Input: available signal types	software programmable	Logic Trigger, Asynchronous Digital-In, Synchronous Digital-In (Digitizer only), Timestamp Reference Clock (Digitizer only)
Input: impedance	software programmable	10 k Ω to 3.3 V or 50 Ω to GND
Input: maximum voltage level		-0.5 V to +4.0 V
Input: signal levels		3.3 V LVTTTL (Low ≤ 0.8 V, High ≥ 2.0 V)
Input: bandwidth		125 MHz
Output: available signal types	software programmable	Asynchronous Digital-Out, Trigger Output, Run, Arm, System Clock, Synchronous Digital-Out (AWG only)
Output: impedance		50 Ω
Output: signal levels		3.3 V LVTTTL
Output: type		3.3V LVTTTL, TTL compatible for high impedance loads
Output: drive strength		Capable of driving 50 Ω loads, maximum drive strength ± 48 mA
Output: internal update rate	M5i.332x, M5i.333x	Current sampling clock ≤ 3.2 GS/s: 1/4 of sampling clock Current sampling clock > 3.2 GS/s: 1/8 of sampling clock
Output: internal update rate	M5i.335x, M5i.336x	Current sampling clock ≤ 5.0 GS/s: 1/4 of sampling clock Current sampling clock > 5.0 GS/s: 1/8 of sampling clock
Output: internal update rate	M5i.63xx	Current sampling clock ≤ 5.0 GS/s: 1/4 of sampling clock Current sampling clock > 5.0 GS/s: 1/8 of sampling clock
Output: min high/low time		4 ns
Output: max signal frequency		125 MHz

Option M5i.xxxx-PulseGen

Number of internal pulse generators	4
Number of pulse generator output lines	4 (Existing multi-purpose outputs X0 to X3)
Time resolution of pulse generator	Pulse generator's sampling rate is derived from instrument's sampling rate and value can be read out. Pulse generator update rate are: 33xx: Base Sampling Rate x Channels / 32 (max 10 GS/s x 1 ch / 32) = 312.5 MS/s (3.2 ns) 63xx: Sampling Rate x Channels / 32 (max 10 GS/s x 1 ch / 32) = 312.5 MS/s (3.2 ns)
Programmable output modes	Single-shot, multiple repetitions on trigger, gated
Programmable trigger sources	Software, Card Trigger, Other Pulse Generator, XIO lines.
Programmable trigger gate	None, ARM state, RUN state
Programmable length (frequency)	2 to 4G samples in steps of 1 (32 bit)
Programmable width (duty cycle)	1 to 4G samples in steps of 1 (32 bit)
Programmable delay	0 to 4G samples in steps of 1 (32 bit)
Programmable loops	0 to 4G samples in steps of 1 (32 bit) with 0 = infinite loops
Output level of digital pulse generators	Please see section of multi-purpose I/O lines.

Bandwidth, Flatness and Slewrate

	Output Amplitude	M5i.635x	M5i.632x
Maximum Output Rate		10 GS/s	3.2 GS/s
-3dB Bandwidth		2.5 GHz	1.5 GHz
Amplitude Flatness 0.5 dB		DC to 2.0 GHz	DC to 1.2 GHz
Slewrate	Single-Ended	7.2 V/ns	4.2 V/ns
Slewrate	Differential	14.4 V/ns	8.4 V/ns

Dynamic Parameters M5i.6350-x16 and M5i.6357-x16

Harmonics and Noise	Single-Ended Output				Differential Output			
	10.0 GS/s		10.0 GS/s		10.0 GS/s		10.0 GS/s	
Test - Samplerate	10.0 GS/s		10.0 GS/s		10.0 GS/s		10.0 GS/s	
Output Frequency	100 MHz		500 MHz		100 MHz		500 MHz	
Output Level in 50 Ω	±250 mV	±500mV	±250 mV	±500mV	±500 mV	±1 V	±500 mV	±1 V
THD (typical)	-60.6 dB	-54.2 dB	-46.8 dB	-40.8 dB	-76.0 dB	-67.5 dB	-66.6 dB	-53.3 dB
HD2 (typical)	-60.6 dBc	-54.5 dBc	-46.8 dBc	-41.1 dBc	-77.4 dBc	-76.7 dBc	-82.0 dBc	-93.0 dBc
HD3 (typical)	-79.5 dBc	-68.5 dBc	-67.9 dBc	-55.7 dBc	-82.0 dBc	-68.2 dBc	-66.8 dBc	-53.2 dBc
HD4 (typical)	-90.5 dBc	-81.8 dBc	-90.0 dBc	-63.7 dBc	-94.0 dBc	-100.0 dBc	-95.0 dBc	-93.0 dBc
NSD (typical)	-151 dBm/Hz	-151 dBm/Hz	-151 dBm/Hz	-151 dBm/Hz	-151 dBm/Hz	-151 dBm/Hz	-151 dBm/Hz	-151 dBm/Hz
SNR (typical)	56.0 dBc	61.0 dBc	56.0 dBc	61.0 dBc	56.0 dBc	61.0 dBc	56.0 dBc	61.0 dBc
SFDR (typ., excl. Harmonics)	-90.0 dBc	-90.0 dBc	-90.0 dBc	-90.0 dBc	-90.0 dBc	-90.0 dBc	-90.0 dBc	-90.0 dBc

Intermodulation Distortion	Single-Ended Output or Differential Output					
	10.0 GS/s		10.0 GS/s		10.0 GS/s	
Test - Samplerate	10.0 GS/s		10.0 GS/s		10.0 GS/s	
Output Frequency	500 MHz ±0.5 MHz		1 GHz ±1.0 MHz		1.5 GHz ±5.0 MHz	
Output Level in 50 Ω	±250 mV	±500mV	±250 mV	±500mV	±250 mV	±500mV
IMD3 (typical)	-76.0 dB	-66.5 dB	-67.4 dB	-53.8 dB	-55.4 dB	-39.4 dB

Phase Noise	Single-Ended Output or Differential Output			
	10.0 GS/s	10.0 GS/s	10.0 GS/s	10.0 GS/s
Test - Samplerate	10.0 GS/s			
Output Frequency	125 MHz	500 MHz	1 GHz	1.5 GHz
Output Level in 50 Ω	±500mV			
Offset 10 Hz	-79 dBc/Hz	-67 dBc/Hz	-61 dBc/Hz	-57 dBc/Hz
Offset 100 Hz	-104 dBc/Hz	-94 dBc/Hz	-85 dBc/Hz	-81 dBc/Hz
Offset 1 kHz	-113 dBc/Hz	-101 dBc/Hz	-96 dBc/Hz	-91 dBc/Hz
Offset 10 kHz	-128 dBc/Hz	-116 dBc/Hz	-110 dBc/Hz	-107 dBc/Hz
Offset 100 kHz	-144 dBc/Hz	-133 dBc/Hz	-127 dBc/Hz	-124 dBc/Hz
Offset 1 MHz	-153 dBc/Hz	-146 dBc/Hz	-140 dBc/Hz	-137 dBc/Hz
Offset 10 MHz	-154 dBc/Hz	-154 dBc/Hz	-155 dBc/Hz	-153 dBc/Hz
Offset 40 MHz	-154 dBc/Hz	-154 dBc/Hz	-155 dBc/Hz	-153 dBc/Hz

THD, SFDR and NSD are measured at the given output level and 50 Ohm termination, differential outputs are measured with a Balun. Calculations are done with built-in calculations from an Siglent SVA1032X Spectrum Analyzer. All available D/A channels are activated for the tests. SNR and SFDR figures may differ depending on the quality of the used PC. NSD = Noise Spectral Density, THD = Total Harmonic Distortion, SFDR = Spurious Free Dynamic Range. Phase Noise is measured with a Holzworth HA7062C Phase Noise Analyzer.

Connectors

Analog Inputs (one for each single-ended input)	33xx		SMA female	Cable-Type: Cab-3mA-xx-xx
Analog Outputs (two for each differential output)		63xx	SMA female	Cable-Type: Cab-3mA-xx-xx
Trigger Input	33xx	63xx	SMA female	Cable-Type: Cab-3mA-xx-xx
Clock Input	33xx	63xx	SMA female	Cable-Type: Cab-3mA-xx-xx
Clock Output	33xx	63xx	SMA female	Cable-Type: Cab-3mA-xx-xx
Multi Purpose I/O	33xx	63xx	SMA female	Cable-Type: Cab-3mA-xx-xx
Power Connector	33xx	63xx	PCIe 6-pin power +12V+GND	Must be supplied by PC power supply.

Connection Cycles

All connectors have an expected lifetime as specified below. Please avoid to exceed the specified connection cycles or use connector savers.

SMA connector	500 connection cycles
PCIe connector	50 connection cycles
PCIe power connector	30 connection cycles

Environmental and Physical Details

Dimension (Card, including rear fans)		L x H x W: 241 mm x 107 mm x 40 mm (double slot width)
Dimension (Card, rear fans, option star-hub)		L x H x W: 241 mm x 107 mm x 60 mm (three slots width)
Weight single M5i card	maximum	780 g
Weight (Option Star-hub, including 8 cables)	maximum	150 g
Warm up time		30 minutes (running acquisition at full speed)
Operating temperature		0°C to 50°C
Storage temperature		-10°C to 70°C
Humidity		10% to 90%
Dimension of packing	1 card	470 mm x 250 mm x 130 cm
Volume weight of packing	1 card	4 kg

PCI Express specific details

PCIe connector type		x16 Generation 3 (Gen3)
PCIe slot compatibility (physical)		x16
PCIe slot compatibility (electrical)		x1, x2, x4, x8, x16 with PCIe Gen1, Gen2, Gen3, Gen4 or Gen5
Sustained streaming mode (Card-to-System):	M5i.33xx	> 12.8 GB/s (measured on PCIe x16 Gen3 with a chipset supporting a 512 bytes TLP) > 11.2 GB/s (measured on PCIe x16 Gen3 with a chipset supporting a 256 bytes TLP)
Sustained streaming mode (System-to-Card):	M5i.63xx	> 11.7 GB/s (measured on PCIe x16 Gen3 with a chipset supporting a 512 bytes TLP) > 10.3 GB/s (measured on PCIe x16 Gen3 with a chipset supporting a 256 bytes TLP)
PCIe max card controller TLP		512 (lower values will limit maximum streaming speed)

Certification, Compliance, Warranty

Conformity Declaration	EN 17050-1:2010	General Requirements
EU Directives	2014/30/EU 2014/35/EU 2011/65/EU 2006/1907/EC 2012/19/EU	EMC - Electromagnetic Compatibility LVD - Electrical equipment designed for use within certain voltage limits RoHS - Restriction of the use of certain hazardous substances in electrical and electronic equipment REACH - Registration, Evaluation, Authorisation and Restriction of Chemicals WEEE - Waste from Electrical and Electronic Equipment
Compliance Standards	EN 61010-1: 2010 EN 61187:1994 EN 61326-1:2021 EN 61326-2-1:2021 EN IEC 63000:2018	Safety regulations for electrical measuring, control, regulating and laboratory devices - Part 1: General requirement Electrical and electronic measuring equipment - Documentation Electrical equipment for measurement, control and laboratory use EMC requirements - Part 1: General requirements EMC requirements - Part 2-1: Particular requirements - Test configurations, operational conditions and performance criteria for sensitive test and measurement equipment for EMC unprotected applications Technical documentation for the assessment of electrical and electronic products with respect to the restriction of hazardous substances
Product warranty	5 years starting with the day of delivery	
Software and firmware updates	Life-time, free of charge	

Power Consumption

		Bus Connector		Power Connector*		Total
		3.3V	12 V	12 V		
M5i.6357-x16	All channels active, differential output with maximum output level possible, 10 MHz sine signal	0.3 A	n.a.	3.1 A		38 W
M5i.6350-x16		0.3 A	n.a.	3.1 A		38 W
M5i.6321-x16		0.3 A	n.a.	3.1 A		38 W
M5i.6320-x16		0.3 A	n.a.	3.1 A		38 W

*A separate power connection to the card is mandatory. The card cannot be powered solely by the PCIe bus connector

MTBF

MTBF

TBD hours

Hardware block diagram

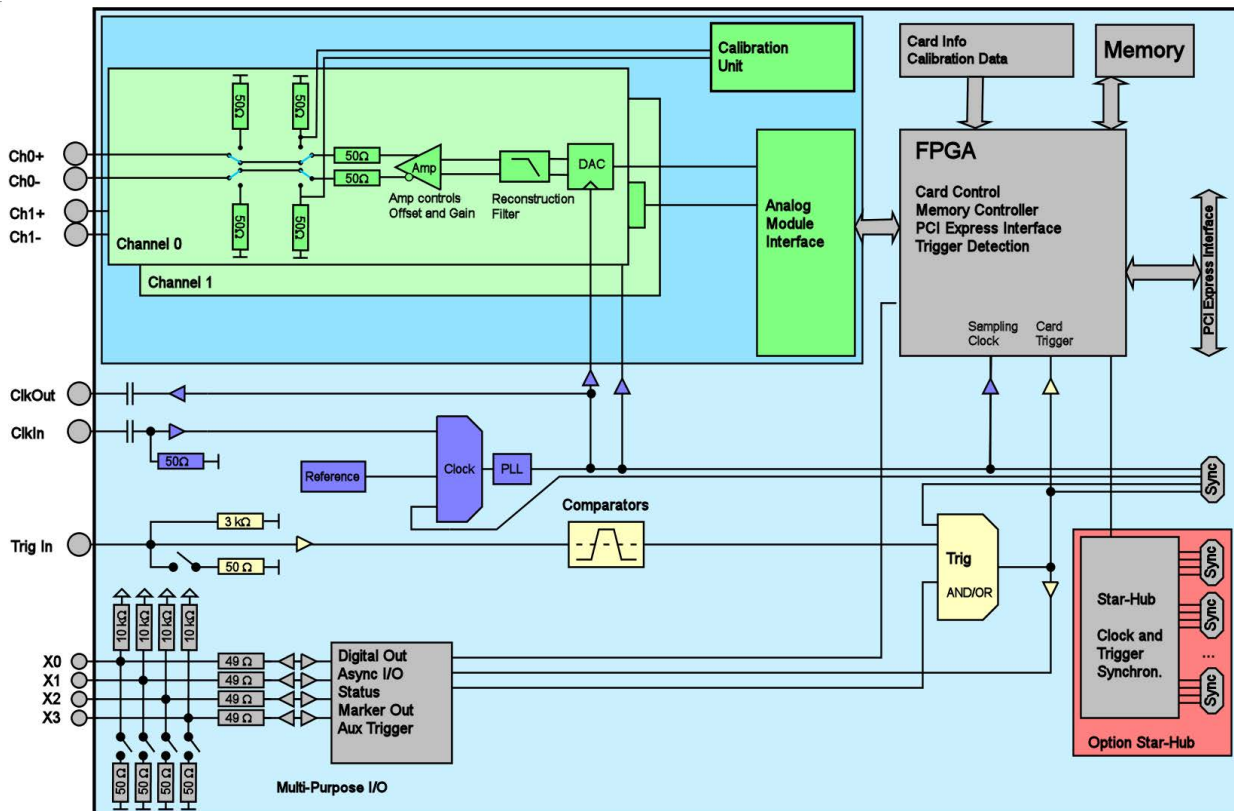

Order Information

The card is delivered with 2 GSamples on-board memory (8 GSamples as option) and supports standard replay, FIFO replay (streaming), Multiple Replay, Continuous Replay (Loop) and Single-Restart. Operating system drivers for Windows/Linux 32 bit and 64 bit, examples for C/C++, LabVIEW (Windows), MATLAB (Windows and Linux), IVI, .NET, Delphi, Java, Python, Julia and a Base license of the measurement software SBench 6 are included.

Adapter cables are not included. Please order separately!

PCI Express x8

Order no.	Bandwidth	Standard mem	Optional mem	1 channel	2 channels
M5i.6320-x16	1.5 GHz	2 GSample	8 GSamples	3.2 GS/s	
M5i.6321-x16	1.5 GHz	2 GSample	8 GSamples	3.2 GS/s	3.2 GS/s
M5i.6350-x16	2.5 GHz	2 GSample	8 GSamples	10 GS/s	
M5i.6357-x16	2.5 GHz	2 GSample	8 GSamples	10 GS/s	5 GS/s

Options

Order no.	Option
M5i.xxxx-MEM8GS	Optional memory extension to 8 GSamples (16 GBytes)
M5i.xxxx-SH8-C2	Synchronization star-hub for up to 8 cards in one system, 2 synchronization cables included
M5i.xxxx-SH8-C4	Synchronization star-hub for up to 8 cards in one system, 4 synchronization cables included
M5i.xxxx-SH8-C8	Synchronization star-hub for up to 8 cards in one system, 8 synchronization cables included
Card-Upgrade	Upgrade for M5i.xxxx: Later installation of star-hub
M5i.xxxx-SyncCable	Additional synchronization cable for connecting star-hub to one card

Firmware Options

Order no.	Option
M5i.xxxx-PulseGen	Firmware Option: adds 4 freely programmable digital pulse generators that use the XIO lines for output (later installation by firmware-upgrade available)

Standard Cables

for Connections	Length	Order no.				
		to BNC male	to BNC female	to SMA male	to SMA female	to SMB female
Analog/Clk/Trig/XIO	80 cm	Cab-3mA-9m-80	Cab-3mA-9f-80	Cab-3mA-3mA-80		Cab-3f-3mA-80
Analog/Clk/Trig/XIO	200 cm	Cab-3mA-9m-200	Cab-3mA-9f-200	Cab-3mA-3mA-200		Cab-3f-3mA-200
Probes (short)	5 cm		Cab-3mA-9f-5			
Information	The standard adapter cables are based on RG174 cables and have a nominal attenuation of 0.3 dB/m at 100 MHz and 0.5 dB/m at 250 MHz. For high speed signals we recommend the low loss cables series CHF					

Low Loss Cables

Order No.	Option
CHF-3mA-3mA-200	Low loss cables SMA male to SMA male 200 cm
CHF-3mA-9m-200	Low loss cables SMA male to BNC male 200 cm
Information	The low loss adapter cables are based on MF141 cables and have an attenuation of 0.3 dB/m at 500 MHz and 0.5 dB/m at 1.5 GHz. They are recommended for signal frequencies of 200 MHz and above.

Services

Order no.	
Recal	Recalibration at Spectrum incl. calibration protocol

Software SBench6

Order no.	
SBench6	Base version included in delivery. Supports standard mode for one card.
SBench6-Pro	Professional version for one card: FIFO mode, export/import, calculation functions, ...
SBench6-Multi	Option multiple cards: Needs SBench6-Pro. Handles multiple synchronized cards in one system.
Volume Licenses	Please ask Spectrum for details.

Software Options

Order no.	
SPc-RServer	Remote Server Software Package - LAN remote access for M2i/M3i/M4i/M4x/M2p/M5i cards
SPc-SCAPP	Spectrum's CUDA Access for Parallel Processing - SDK for direct data transfer between Spectrum card and CUDA GPU. Includes RDMA activation and examples.

Technical changes and printing errors possible

SBench, digitizerNETBOX, generatorNETBOX and hybridNETBOX are registered trademarks of Spectrum Instrumentation GmbH. Microsoft, Visual C++, Windows, Windows 98, Windows NT, Windows 2000, Windows XP, Windows Vista, Windows 7, Windows 8, Windows 10 and Windows 11 are trademarks/registered trademarks of Microsoft Corporation. LabVIEW, DASyLab, Diadem and LabWindows/CVI are trademarks/registered trademarks of National Instruments Corporation. MATLAB is a trademark/registered trademark of The Mathworks, Inc. Delphi and C++ Builder are trademarks/registered trademarks of Embarcadero Technologies, Inc. IVI is a registered trademark of the IVI Foundation. Oracle and Java are registered trademarks of Oracle and/or its affiliates. Python is a trademark/registered trademark of Python Software Foundation. Julia is a trademark/registered trademark of Julia Computing, Inc. PCIe, PCI Express and PCI-X and PCI-SIG are trademarks of PCI-SIG. LXI is a registered trademark of the LXI Consortium. PICMG and CompactPCI are trademarks of the PCI Industrial Computation Manufacturers Group. Intel and Intel Core i3, Core i5, Core i7, Core i9 and Xeon are trademarks and/or registered trademarks of Intel Corporation. AMD, Opteron, Sempron, Phenom, FX, Ryzen and EPYC are trademarks and/or registered trademarks of Advanced Micro Devices. Arm is a trademark or registered trademark of Arm Limited (or its subsidiaries). NVIDIA, CUDA, GeForce, Quadro, Tesla and Jetson are trademarks/registered trademarks of NVIDIA Corporation.